

# JERGI

Art.-Nr.

399 080  
399 082  
399 083  
399 084

↔ 675  
↕ 2100  
↗ 670  
mm

1/6  
VO  
38-2024

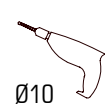
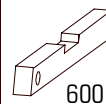
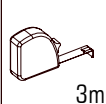
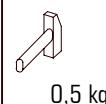
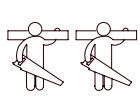



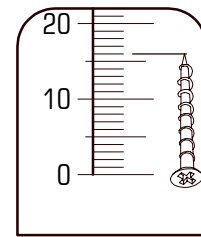
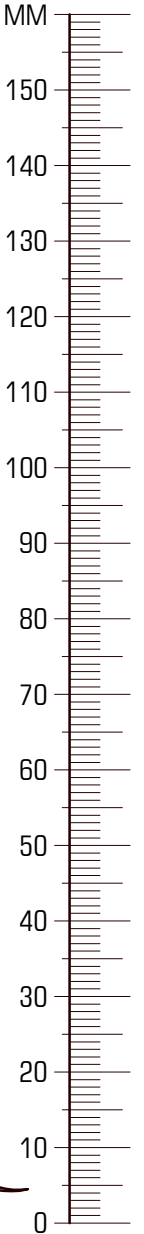
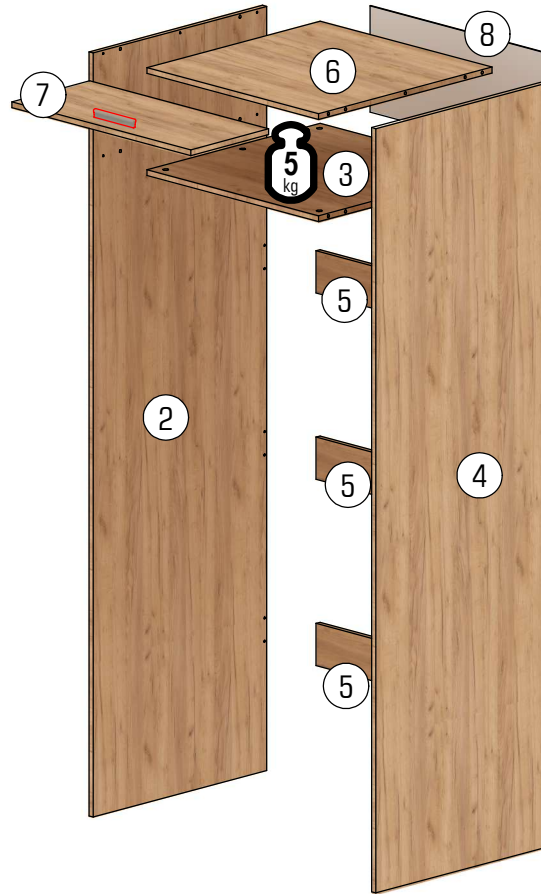
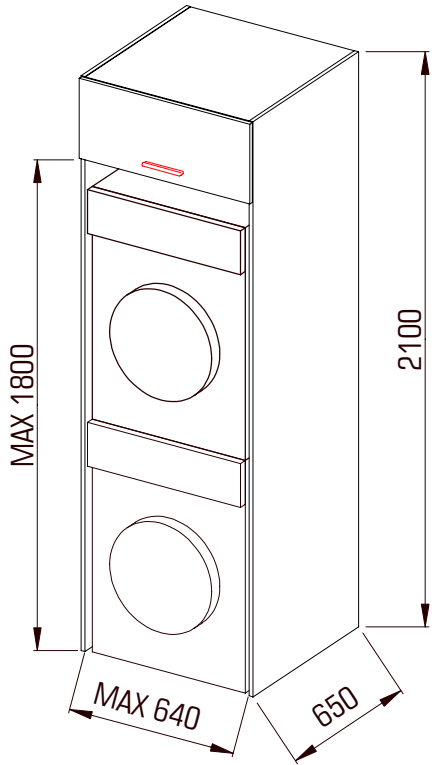
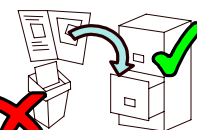
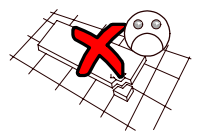
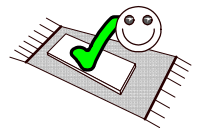
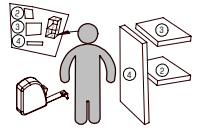
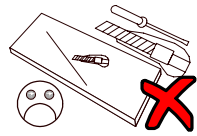

ID EE	ID			
21663	②	2100*650*16	1x	1/2
21664	③	643*649*16	1x	2/2
21665	④	2100*650*16	1x	1/2
21666	⑤	643*116*16	3x	2/2
21692	⑥	643*649*16	1x	2/2
21667	⑦	670*292*16	1x	2/2
21668	⑧	670*292*3	1x	2/2

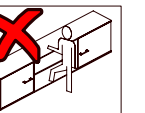
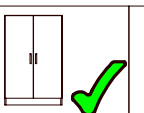
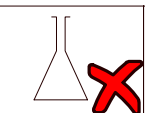

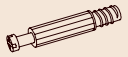

	22243.00		22280.00		27000.00		8402.03		70013.01		70021.01		30091.00		
A	12x	B	4x	C	2x	D	8x	E	1x	F	24x	G	24x	H	4x
	31103.00		22244.01		24101.00		22256.00		21102.00		36002.07		36002.07		32030.00
J	4x	K	8x	L	4x	M	4x	N	25x	P	2x	Q	2x	R	1x
	70603.00		70603.00		70603.00		70603.00		70603.00						
V1	1x	V2	1x	V3	1x	V4	3x	V5	2x						





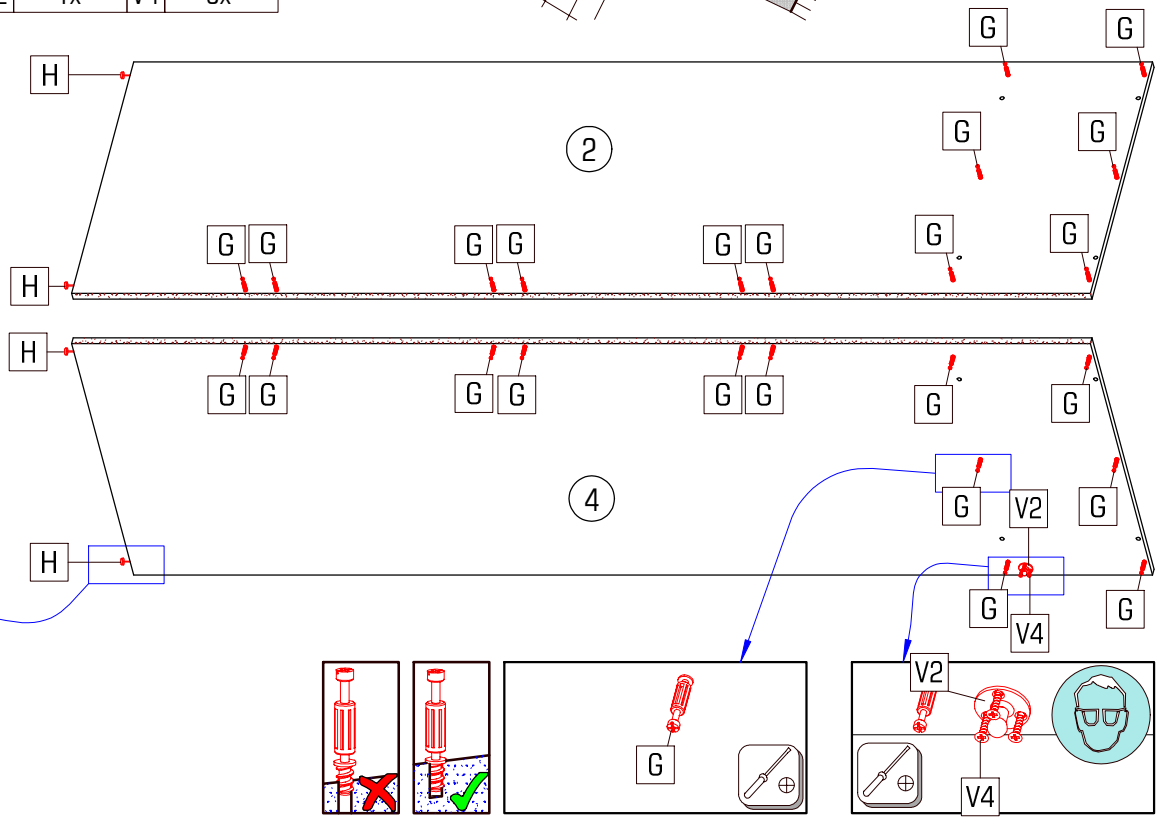
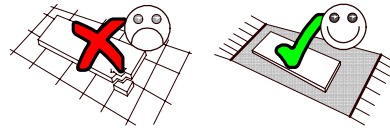

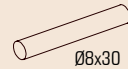

# 2/6 JERGI

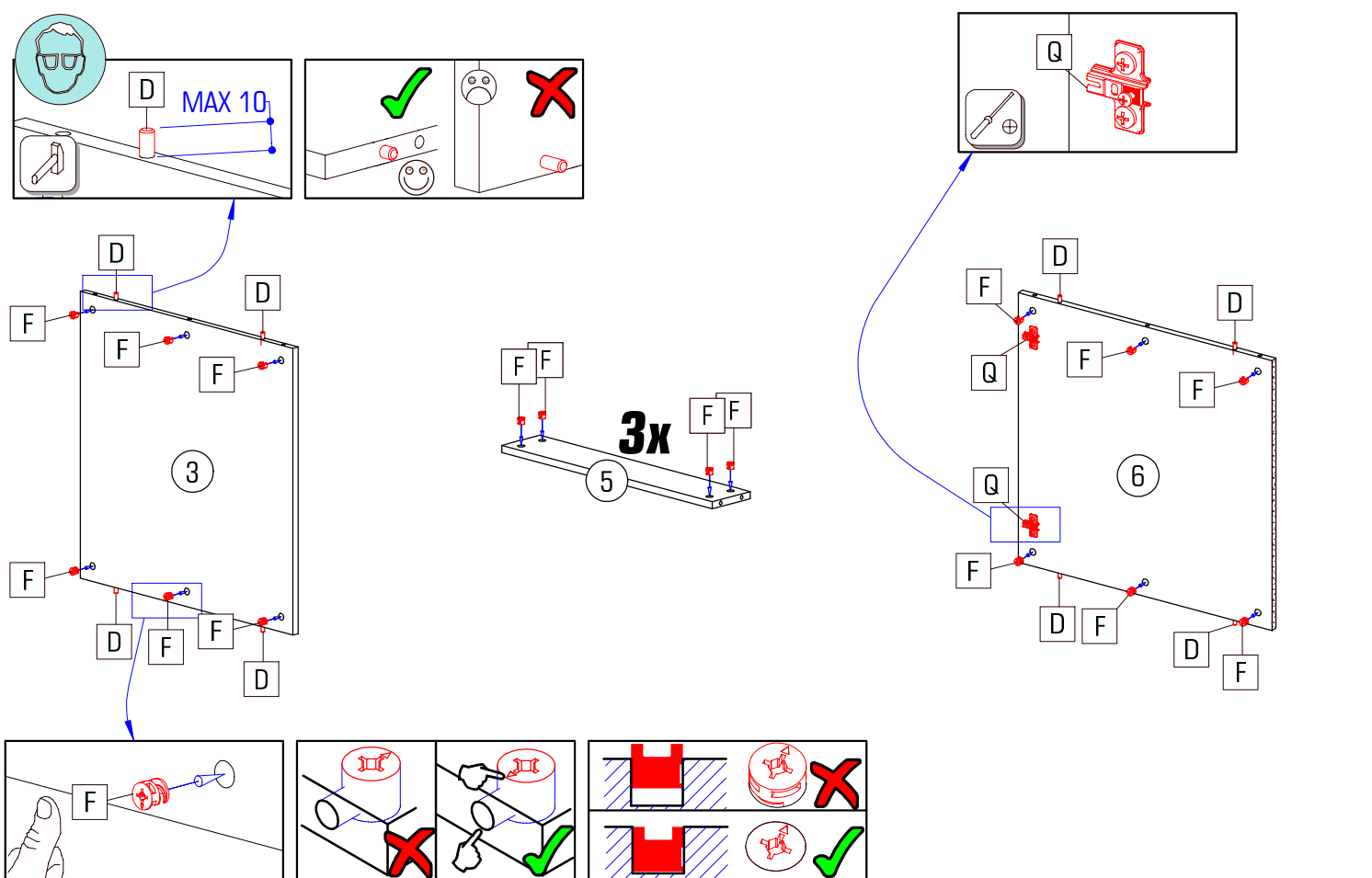
			
G 24x	H 4x	V2 1x	V4 3x



		
D 8x	F 24x	Q 2x



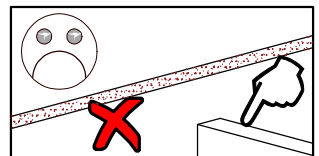
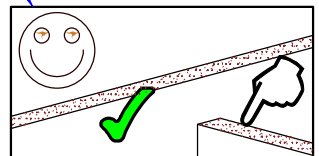
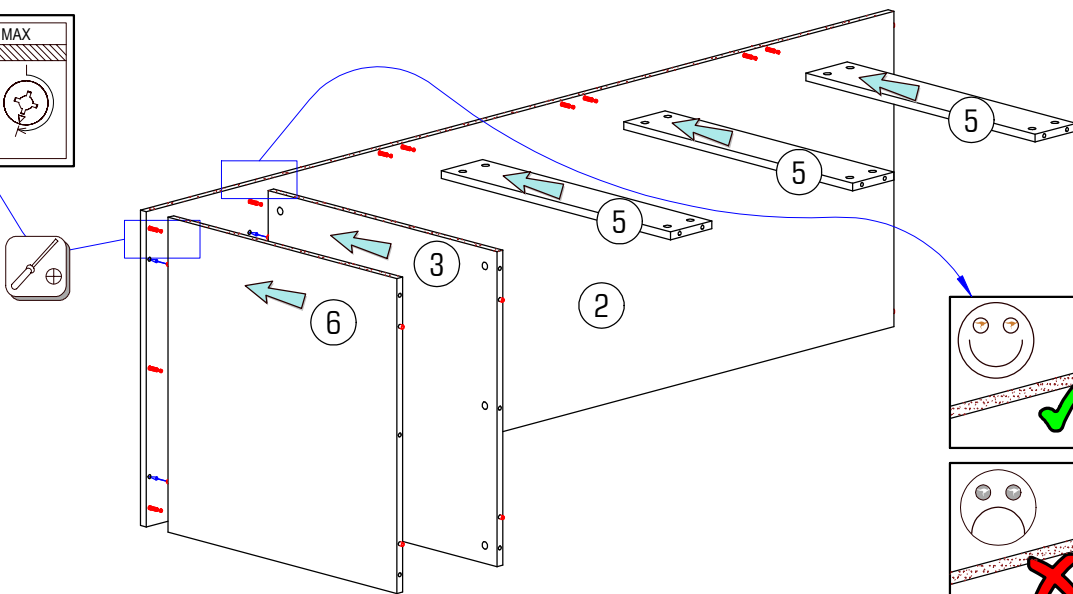
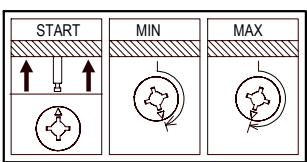
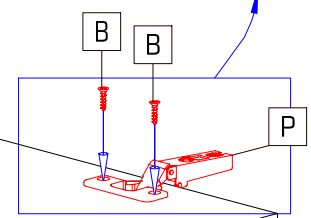
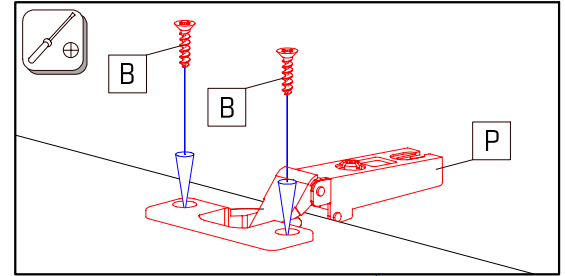
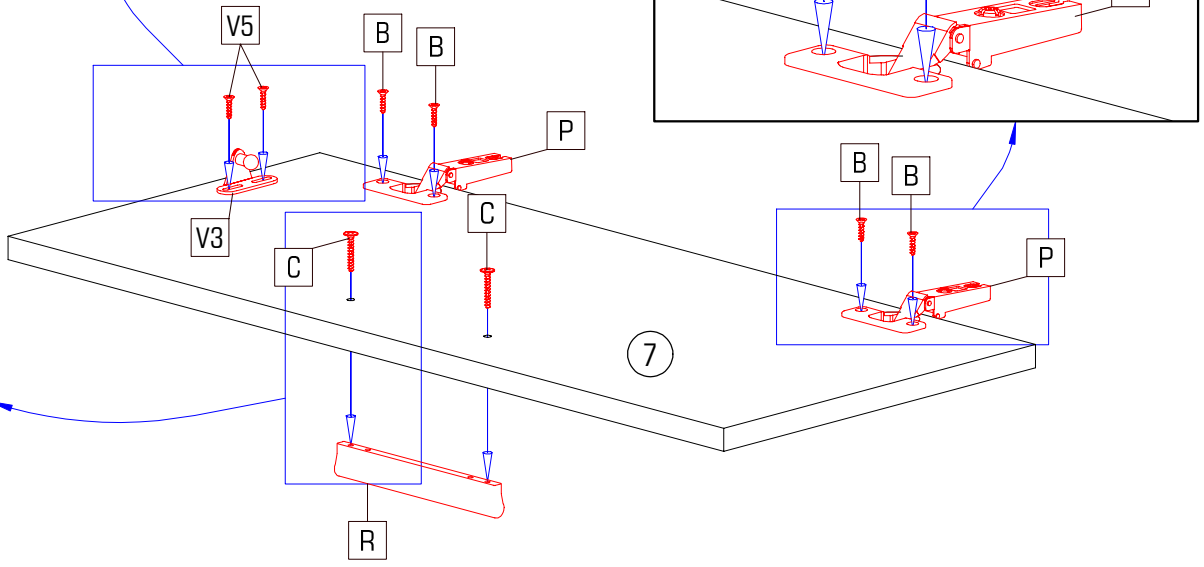
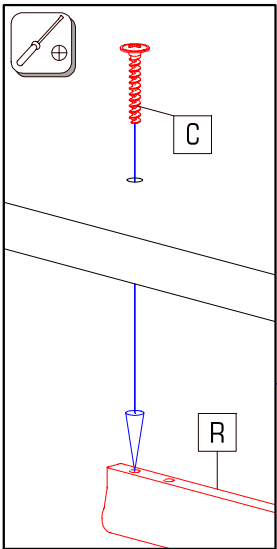
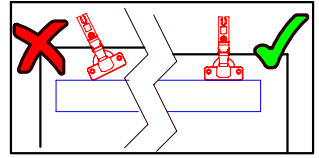
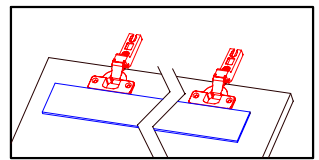
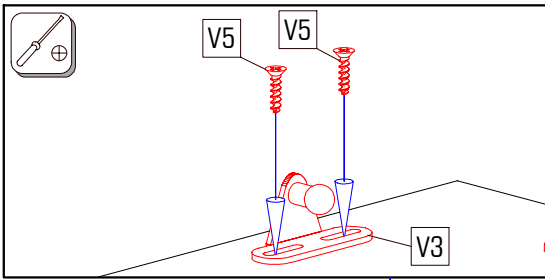

					
B	C	P	R	V3	V5
4x	2x	2x	1x	1x	2x

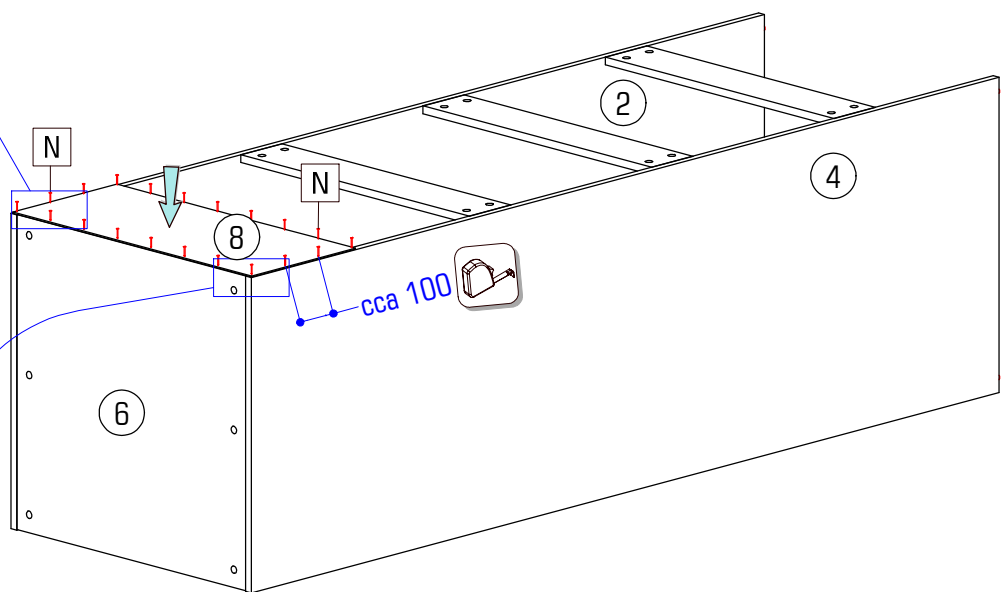
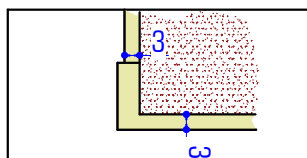
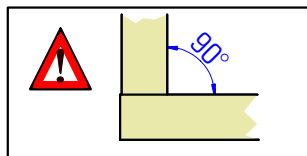
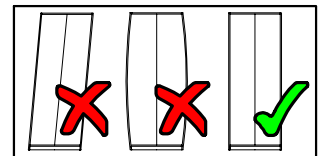
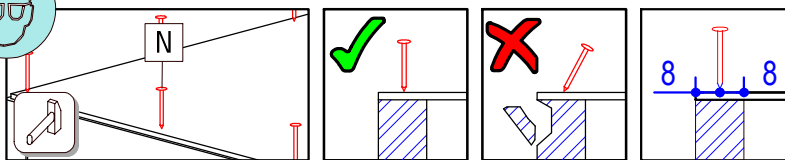
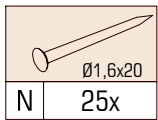
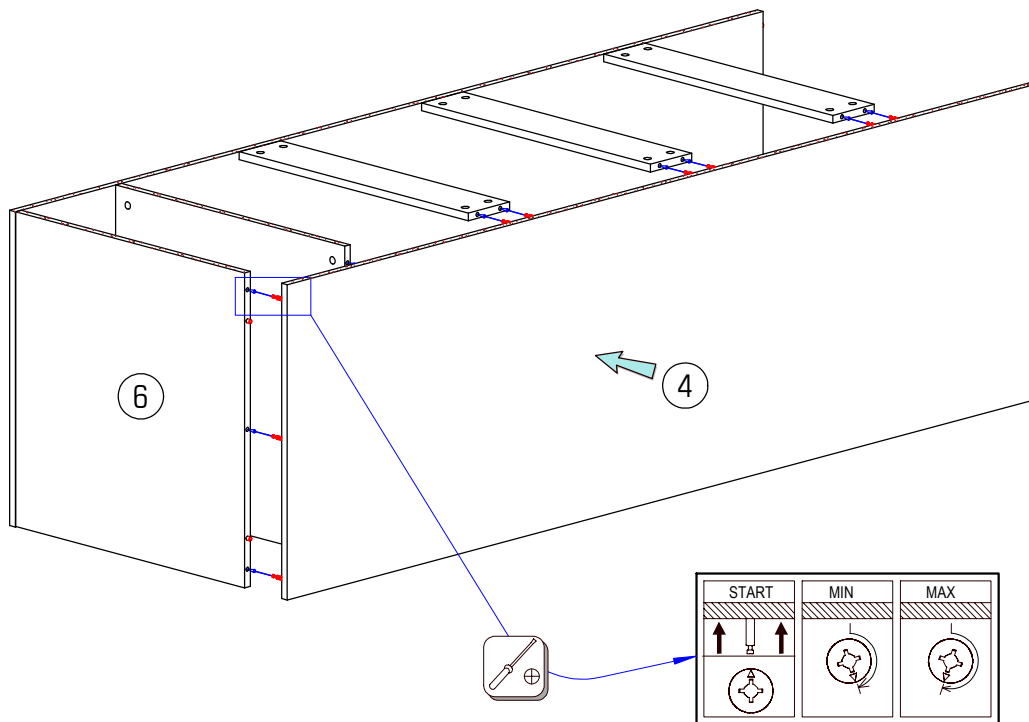

# 4/6 JERGI

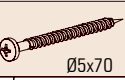

			
J	K	L	M
4x	8x	4x	4x

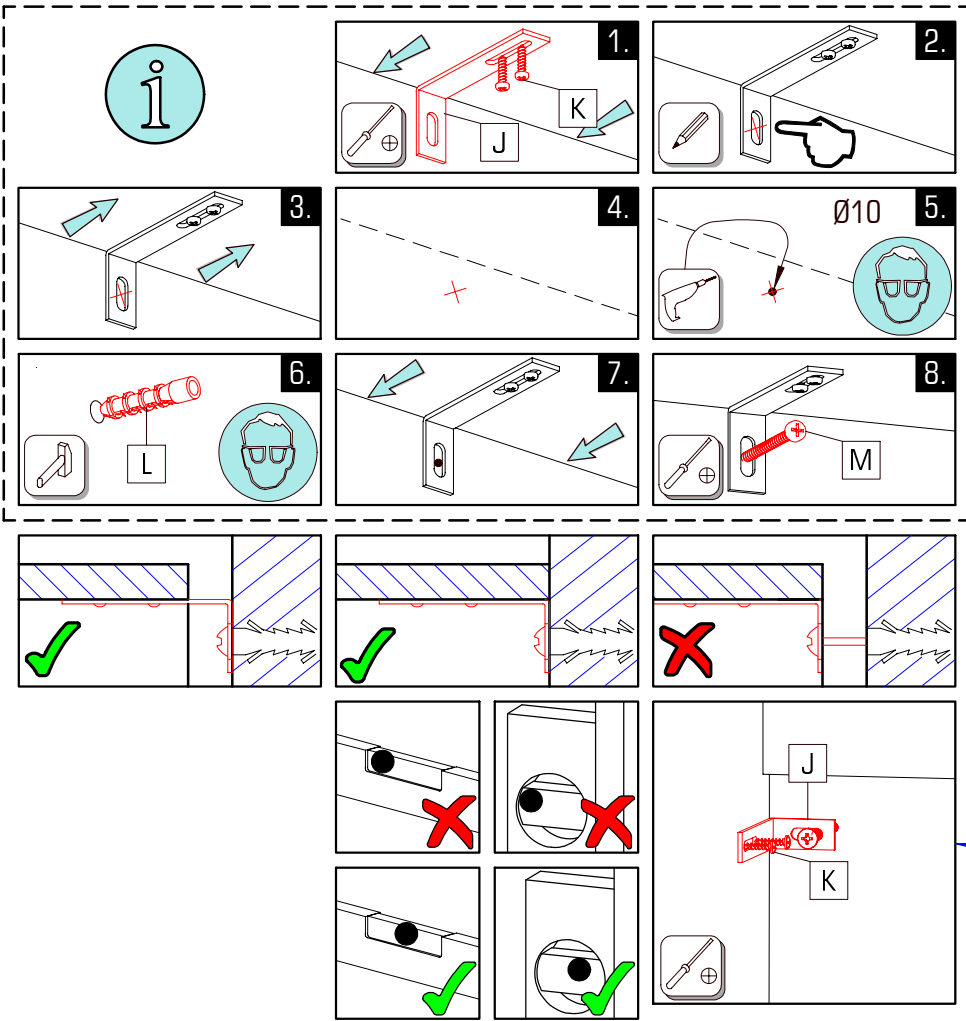

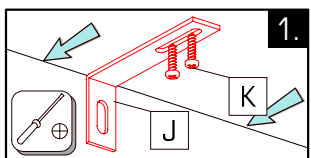
**1.** 

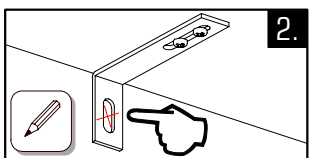
**2.** 

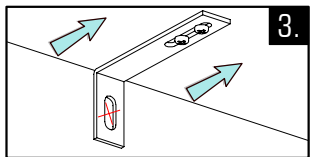
**3.** 

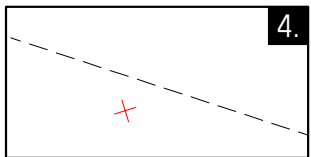
**4.** 

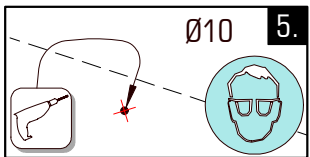
**5.** 

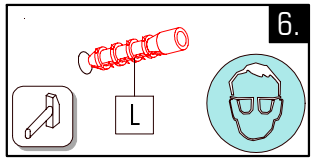
**6.** 

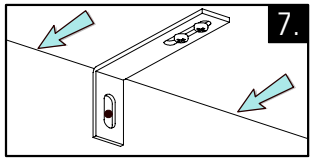

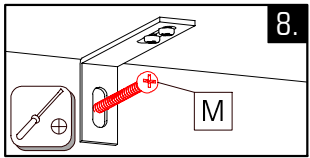

**7.** 

**8.** 

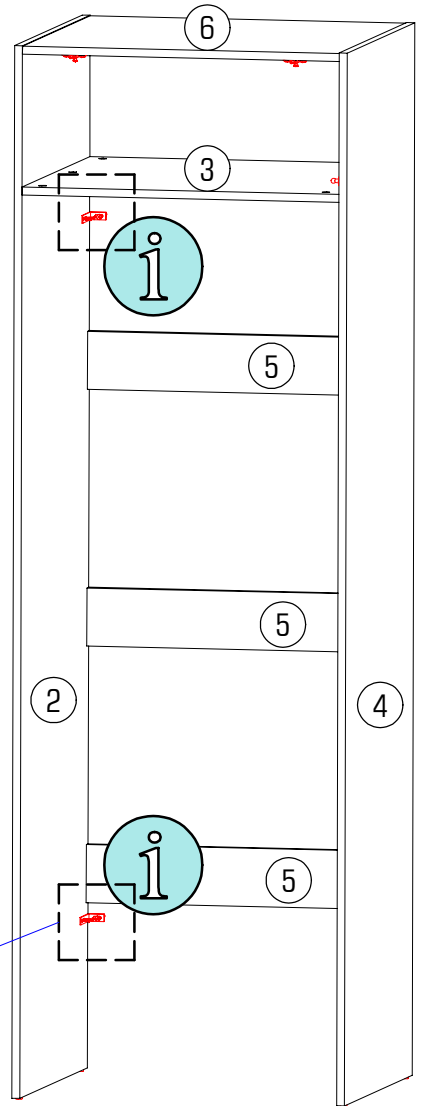
**Diagrams:**

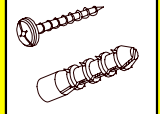
- Correct installation: Screws are inserted into solid masonry (concrete/brick).
- Incorrect installation: Screws are inserted into hollow brick, lightweight blocks, or gypsum board.
- Correct placement: Screws are placed in the center of the wall.
- Incorrect placement: Screws are placed too close to the edge or in a corner.

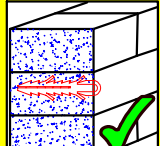

- SK VÝSTRAHA
- CZ VAROVÁNÍ
- HR UPOZORENIE
- DE WARNUNG
- HU FIGYELEM
- PL OSTRZEŻENIE
- RO AVERTIZARE
- EN WARNING
- SI OPOZORILO

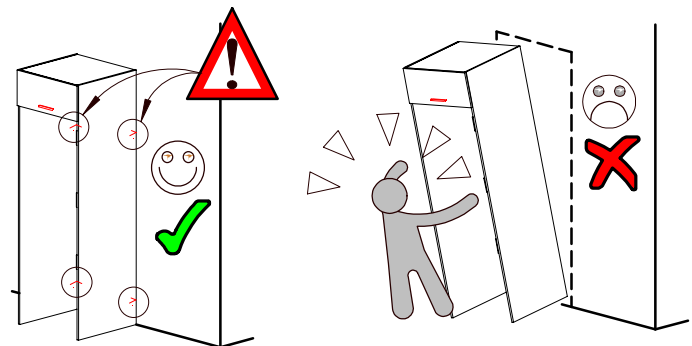

**PL** Uwaga! Ścianę należy sprawdzić przed montażem. Dołączone uniwersalne kolki rozporowe są odpowiednie tylko do stosowania w mocnych murach, takich jak beton lub cegła. Nie rób za pomocą kolków ozporowych murowanych, takich jak pustak, lekka kostka, powierzchnie takie jak płyty gipsowo-kartonowe lub inne systemy ram. Jeśli dotyczy, muszą to być określone kolki rozporowe być użyty! Są one dostępne w specjalistycznym sklepie niezgodność, producent / sprzedawca lub importer nie ponoszą odpowiedzialności.

**RO** Prudență! Zidul trebuie examinat înainte de asamblare prizele de perete sunt adecvatenumai pentru utilizarea în zidurile fermă, cum ar fi betonul sau bloc cărămidă. Nu folosiți zidăria zidurilor de perete, cum ar fi cărămida goală, blocul ușor, suprafețe cum ar fi gips-carton sau altă încadrare sisteme. Dacă este cazul, trebuie folosite anumite prize de perete! Acestea sunt disponibile la un magazin specializat (magazin de hardware) . În caz de nerespectare, producătorul / vânzătorul cu amănuntul sau importatorul nu își asumă răspunderea.

**SI** Pozor! Pred montažo preverite stanje stene. Priloženi univerzalni mozniki so izključno samo za uporabo na čvrstem zidovju, kot sta beton in opeka. Stenski mozniki se ne smejo uporabljati pri zidovju kot so votlino opeke, zidaki za lahko gradnjo, mavčne plošče ali druge okvirne gradnje. Pri teh zidovjih morate v danih primerih uporabljati posebne moznike. Ti so na voljo v specializiranih trgovinah (trgovinah z gradbenim materialom) brez preizkušanja. Pri upoštevanju se s strani proizvajalca/trgovca in uvoznika ne prevzame jamstvo.

**DE** Achtung! Die Wandbeschaffenheit ist vor der Montage unbedingt zu prüfen. Die beigelegten Universaldübel sind ausschließlich nur zur Verwendung für festes Mauerwerk wie Beton/Ziegel. Die Mauerdübel dürfen nicht bei Mauerwerk wie Hohlraumziegel, Leichtbausteinen, Gipskartonplatte oder anderer Rahmenbauweise verwendet werden. Bei diesen Mauerwerken sind gegebenenfalls Spezialdübel zu verwenden! Diese sind in einem Fachgeschäft erhältlich. Bei Nichteinhaltung wird seitens Produzenten/Händler und Importeur keine Haftung übernommen.

**HR** Pažnja! Prije montaže obavezno provjerite svojstvo zida. Priložene univerzalne tiplje namijenjene su isključivo za masivne zidove od betona/opeke. Tiplje za masivne zidove ne smiju se koristiti za zidove kao npr šupljina opeka laki sastavni elementi, gips-kartonske ploče ili drugi modularni načini gradnje. Za te zidove potrebne su eventualno specijalne tiplje! Iste su dostupne u specializiranim trgovinama građevinskim materijalom. U slučaju nepridržavanja prethodno navedenih napomena, proizvođač/trgovac i uvoznik ne preuzimaju odgovornost!

**HU** Vigyázat! Szerelés előtt a falfelületet feltétlenül vizsgálja meg. A mellékelt univerzális tiplj kizárólag stabil falazathoz használható mint például beton/tégla. A fali tiplj nem használható könnyű építőkövekhez, üreg tégla, gipszkarton lapokhoz vagy más favázás építményekhez. Ezekhez a falfelületekhez csak speciális tiplik használhatóak, melyek szaküzletekben (barkácsáruházakban) beszerezhetőek. Fentiek figyelmen kívül hagyása esetén a gyártó/kereskedő vagy forgalmazó nem vállal felelősséget.

**EN** Caution! The wall must be examined before assembly. The included universal wall plugs are only suitable for using in firm masonry such as concrete block or brick. Do not use the wall plugs masonry such as hollow brick, lightweight block, surfaces such as gypsum plasterboard or other framing systems. If applicable, particular wall plugs must be used! These are available at a specialised store (hardware store). In case of non-compliance, the manufacturer/retailer or importer do not assume liability.

**CZ** Upozornění! Před montáží je nutné zkontrolovat stav stěny. Přiložené univerzální hmoždinky jsou určeny pouze k použití pro pevné zdivo jako beton/cihly. Hmoždinky do zdi se nesmí používat u dutinová cihla, zdiva jako pórovitý stavební kámen, sádrokartonová deska nebo jiný měkký materiál. U těchto zdiv jsou nutné použít speciální hmoždinky! Jsou k dostání v speciálních prodejnách se stavebním materiálem. Při nedodržení těchto pokynů výrobce/prodejce a dovozce neručí za způsobené škody.

**SK** Upozornenie! Pevnosť steny sa musí pred montážou bezpodmienečne skontrolovať. Priložené univerzálne hmoždenky používajte jedine pre pevné murivo ako je betón/tehla. Hmoždenky sa nesmú používať v prípade ľahkého stavebného muriva, dutá tehla, Sádorkartónová doska, alebo iných konštrukcií rámu. U týchto stien je nutné použiť špeciálne hmoždenky! Tieto je možné dostať v špeciálnych predajniach so stavebným materiálom. Pri nedodržaní pokynov nepreberajú výrobcovia/predajci a dodávateľa zodpovednosť za vzniknuté škody.

# 6/6 JERGI

A	12x	E	1x
		V1	1x

